



VIJAY
ALUMINIUM







ABOUT US

Established in 1995, Vijay Aluminium is a leading Fabrication of Aluminium Window, Doors, Partation and much more. These are manufactured at our modern Production Facility by using premium quality aluminium as a key raw material. The products offered by us are highly acclaimed for their ease of installation and use, corrosion resistance and minimal maintenance needs. These products are available to clients in multiple specifications of size, shape and design. We have also a Dealership of glass Company like Modiguard, Saint Gobain, Ashahi and much more. We are also a service proviser of Glass Cutting and Shipping Service for fabricators.

We pride ourselves on our workmanship and communication with our customers, our experienced fitting team are there to make sure your installation runs smoothly.

We are supported by a dedicated team of skilled workforce that enables us in catering the requirements of the clients spread across the state. Our team comprises of procurement agents, quality controllers and others who work in proximity with each other to deliver the good within the stipulated time frame at the client's door step.

We have build with architects and builders along with prestigious window manufacturers. We are proud of offer you an extensive range of products that will suit every building and renovation project in any style of home, from traditional, to contemporary and right throught to ultra modern, architectural designs.

VIJAY ALUMINIUM



INDEX

SLIDING WINDOW AND DOOR SYSTEMS

23 MM SLIDING SYSTEM

25 MM SLIDING SYSTEM

27 MM SLIDING SYSTEM

27 MM PREMIUM SLIDING SYSTEM

29 MM SLIDING SYSTEM

32 MM SLIDING SYSTEM

32 MM PREMIUM SLIDING SYSTEM

35 MM SLIDING SYSTEM

37 MM SLIDING SYSTEM

VIJAY ALUMINIUM



INDEX

CASEMENT WINDOW SYSTEMS

40 MM CASEMENT SYSTEM

42 MM CASEMENT SYSTEM

50 MM CASEMENT SYSTEM

52 MM CASEMENT SYSTEM

DOOR SYSTEMS

40 MM DOOR SYSTEM

50 MM DOOR SYSTEM

VIJAY ALUMINIUM

ABOUT SLIDING SYSTEMS

Sliding window features two (or more) horizontal sashes fitted with rollers at the bottom for swift sideways movement on tracks. Easier and faster to operate, they are great for air circulation and panoramic views. A popular choice for contemporary styled homes sliders bring finesse to the room while satisfying all its fenestration requirements.

FEATURES & BENEFITS

- Improved ventilation as sashes can be moved left or right
- Low friction between rollers and track for smooth sliding motion
- Multi-track and sash options to cover larger spans
- Available in variety of designs, colours and hardware
- Optimised space usage as the sashes slide and do not open inwards
- Air-tight seals for Better noise, dust, heat and pollution reductions.
- Monsoon track for heavy rains, and hurricane bars for high speed winds

RECOMMENDED FOR

- Bedrooms, Balconies, Large/Tall openings



ABOUT SLIDING DOOR SYSTEMS

The sliding Door is made up of two (or more) sashes that slide horizontally, to the left or right, on tracks. The doors can be made wider and taller with the addition of sashes. The sliders work on a 'ride over' mechanism and make most of the space, by providing unhindered access as doors do not encroach upon the room when open. Moving effortlessly and quietly, doors close smoothly with Silent System.

FEATURES & BENEFITS

- Customizable and Extremely versatile
- Available in variety of colours and designs
- Giant doors possible for large views
- Multi-chamber system increases heat and sound insulation
- Multi-point locking systems for enhanced security
- Double and triple glass options for better insulation
- Hurricane bar option to withstand storms
- Rain track and sill for insulation against rain

RECOMMENDED FOR

- Large/tall Openings, Balconies and High Rise Buildings





V2358EWD

23 MM SLIDING SYSTEM

KEY FEATURES

- Premium Quality Aluminum Profiles
- European Design
- Glazing from 4mm to 8mm
- Single Roller Capacity 60 kg
- Double Roller Capacity 80-110kg
- Smooth & Effortless in movement
- Singlepoint locksystem
- Available in Anodized, Powder Coating, PVDF & Wood Finish
- Design for Small and Medium size shutter sliding
- Alloy 6063-T6 Temper as per IS- 6477 1983 for dimensional tolerances and Mechanical properties
- Available in Clear Glass, Reflective Glass & Toughned Glass
- Provision for insect screen

VIJAY ALUMINIUM



THREE TRACK SYSTEM

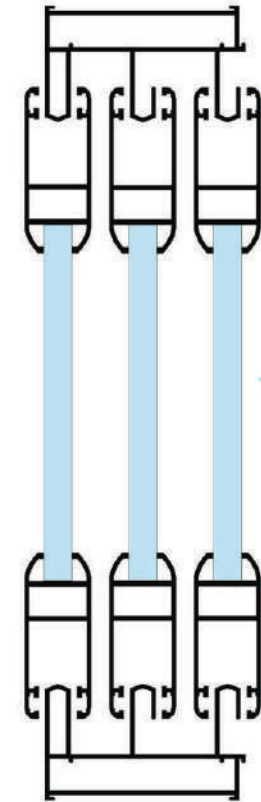
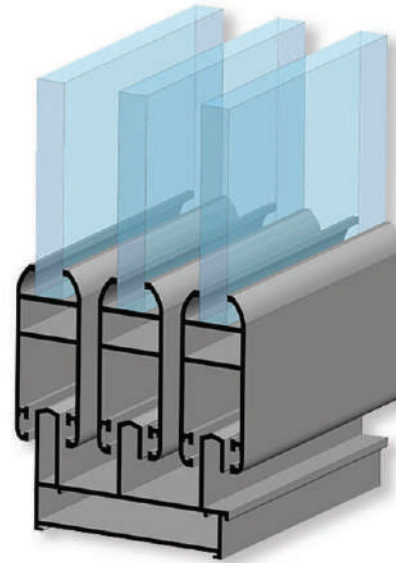

SIDE VIEW

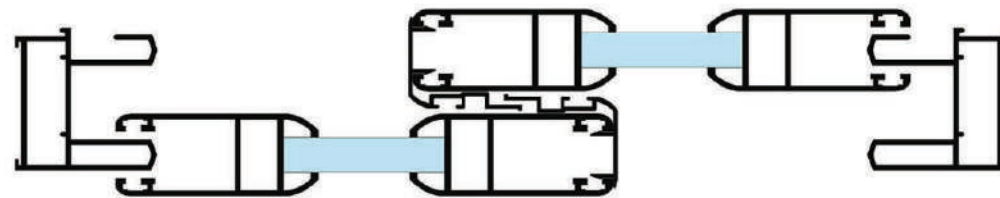



TOP VIEW

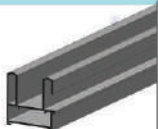
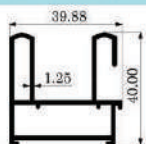

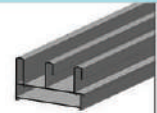
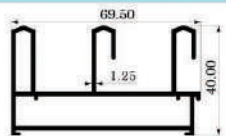

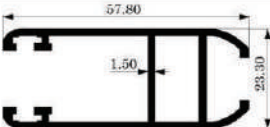
23MM TWO TRACK		
		All Side Frame Section
		Section Number 1203
		Weight (kg/mt) 0.765

23MM THREE TRACK		
		All Side Frame Section
		Section Number 1206
		Weight (kg/mt) 1.093

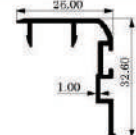
23MM SINGLE GLASS SHUTTER		
		4 - 8 mm Glass Shutter
		Section Number 1208
		Weight (kg/mt) 0.661

23MM INTERLOCK CLIP		
		Inter. Clip For Section
		Section Number 1027
		Weight (kg/mt) 0.273

MOSQUITO CLIP		
		Mosquito Screen Fitting Clip
		Section Number 1269
		Weight (kg/mt) N/A



V2563EWD

25 MM SLIDING SYSTEM

KEY FEATURES

- Premium Quality Aluminum Profiles
- European Design
- Glazing from 5mm to 15mm
- Single Roller Capacity 60 kg
- Double Roller Capacity 90-150kg
- Smooth & Effortless in movement
- Manual concealed & Multipoint locksystem
- Provision for insect screen
- Available in Anodized, Powder Coating, PVDF & Wood Finish
- Design for Small and medium size shutter sliding
- Alloy 6063-T6 Temper as per IS- 6477 1983 for dimensional tolerances and Mechanical properties
- Bug & Bugler proof window
- Dust Resistance & Better Sound Reduction
- Available in Clear Glass, Reflective Glass, Toughned Glass

VIJAY ALUMINIUM



THREE TRACK WITH FLY SCREEN SHUTTER

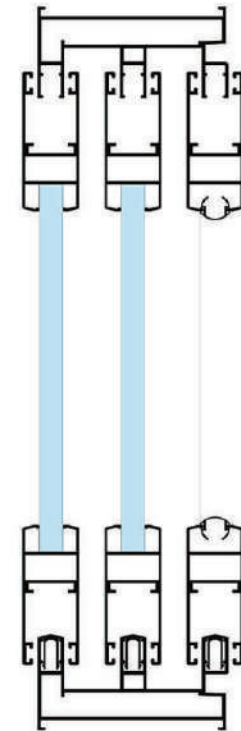
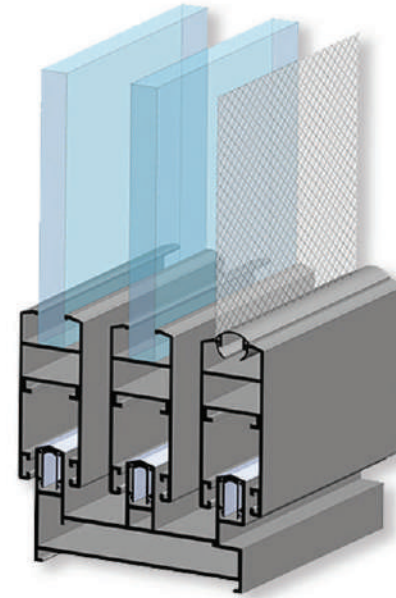

SIDE VIEW

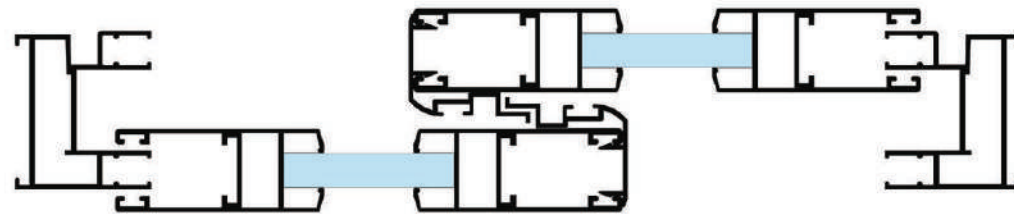

TOP VIEW

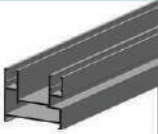
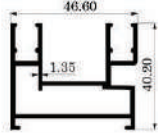

25MM TWO TRACK		
		Basic Model
		Section Number 1110
		Weight (kg/mt) 0.883

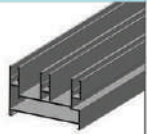
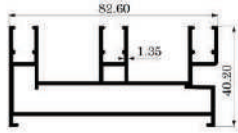
25MM THREE TRACK		
		Basic Model
		Section Number 1109
		Weight (kg/mt) 1.47

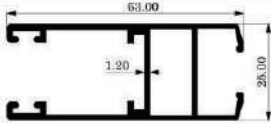
25MM SHUTTER		
		4 - 8 mm Glass Shutter
		Section Number 1095
		Weight (kg/mt) 0.753

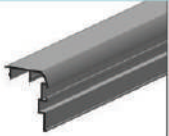
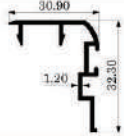
25MM INTERLOCK CLIP		
		Universal Clip
		Section Number 1108
		Weight (kg/mt) 0.393

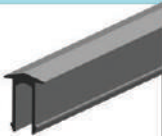
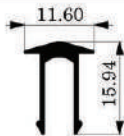
25MM TRACK RAIL CAP		
		"V" Type
		Section Number 1107
		Weight (kg/mt) 0.156

Mosquito Clip		
		Mosquito screen Fitting Clip
		Section Number 1269
		Weight (kg/mt) N/A



V2765EWD

27 MM SLIDING SYSTEM

KEY FEATURES

- Premium Quality Aluminum Profiles
- European Design
- Glazing from 5mm to 16mm
- Single Roller Capacity 65 kg
- Double Roller Capacity 100-160kg
- Smooth & Effortless in movement
- Manual concealed & Multipoint locksystem
- Provision for insect screen
- Available in Anodized, PowderCoating, PVDF & Wood Finish
- Design for Small size shutter sliding Alloy 6063-T6 Temper as per IS- 6477 1983 for dimensional tolerances and Mechanical properties
- Bug & Bugler proof window
- Dust Resistance & Better Sound Reduction
- Available in Clear Glass, Reflective Glass, Toughned Glass, DGU Glass & Laminated Glass
- Reinforced Profiles available in larger opening

VIJAY ALUMINIUM



TWO TRACK SHUTTER

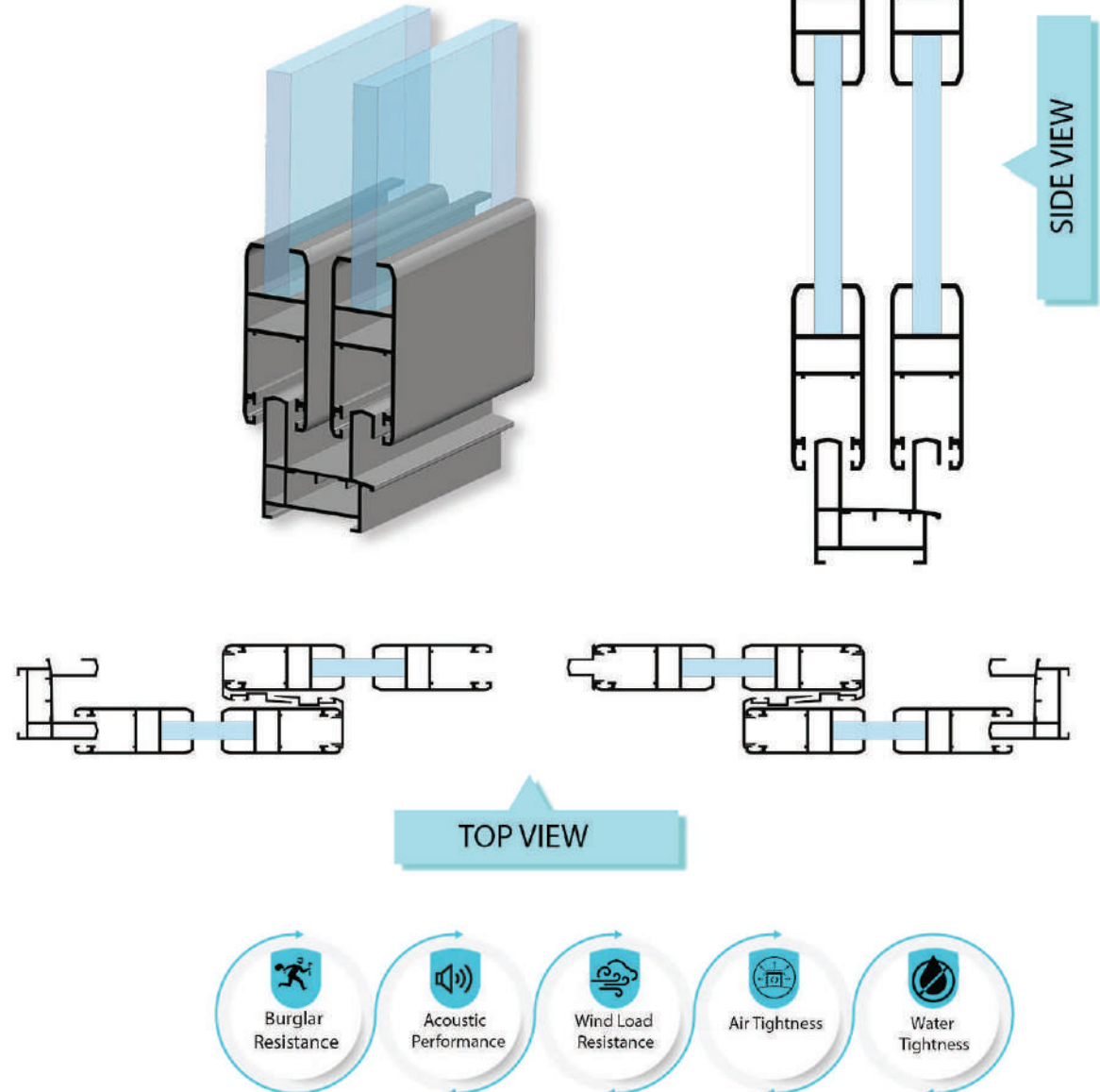

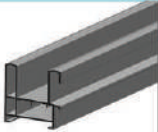
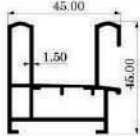
27MM TWO TRACK		
		Basic Model
		Section Number 1124 Weight (kg/mt) 1.004

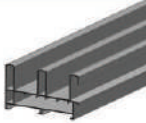
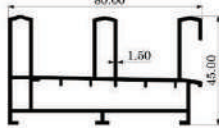
27MM THREE TRACK		
		Basic Model
		Section Number 1126 Weight (kg/mt) 1.355

27MM FOUR TRACK		
		Single Leg Section
		Section Number 1133 Weight (kg/mt) 2.340

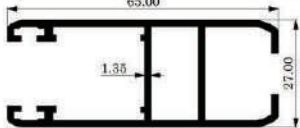

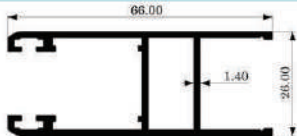
27MM SHUTTER		
		Single Glass Shutter
		Section Number 1006 Weight (kg/mt) 0.855

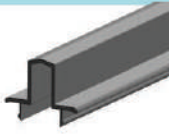
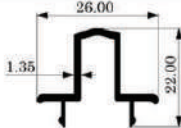
27MM SHUTTER		
		DGU Glass Shutter
		Section Number 1131 Weight (kg/mt) 0.778

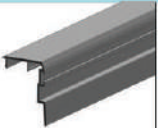
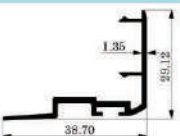
27MM SHUTTER CAP		
		Meeting Section
		Section Number 1129 Weight (kg/mt) 0.254

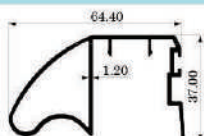
27MM INTERLOCK CLIP		
		Universal Clip
		Section Number 1001 Weight (kg/mt) 0.303

27MM INTERLOCK CLIP		
		Reinforcement Interlock
		Section Number 1197 Weight (kg/mt) 0.711

MOSQUITO CLIP		
		Mosquito Screen Fitting Clip
		Section Number 1269 Weight (kg/mt) N/A



V2765EDW

27 MM SLIDING SYSTEM

KEY FEATURES

- Premium Quality Aluminum Profiles
- European Design
- Glazing from 5mm to 15mm
- Single Roller Capacity 60 kg
- Double Roller Capacity 110-170kg
- Smooth & Effortless in movement
- Manual concealed & Multipoint locksystem
- Provision for insect screen
- Available in Anodized, Powder Coating, PVDF & Wood Finish
- Design for Large size shutter sliding Alloy 6063-T6 Temper as per IS- 6477 1983 for dimensional tolerances
- Bug & Bugler proof window Dust Resistance & Better Sound Reduction
- Available in Clear Glass, Reflective Glass, Toughned Glass, DGU Glass & Laminated Glass
- Reinforced Profiles available in larger opening

VIJAY ALUMINIUM



FOUR TRACK SHUTTER

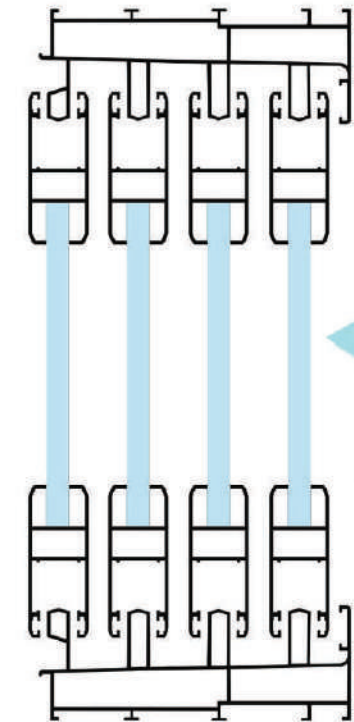
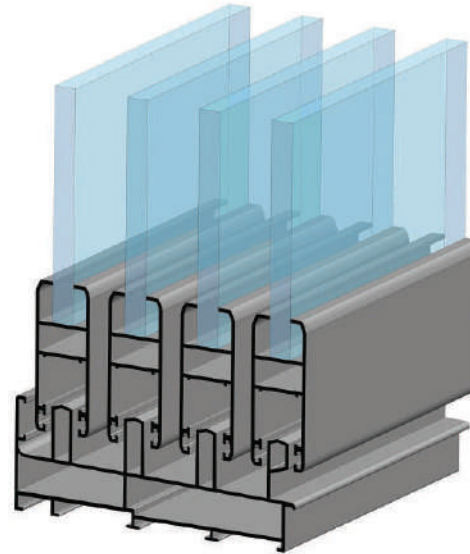

SIDE VIEW

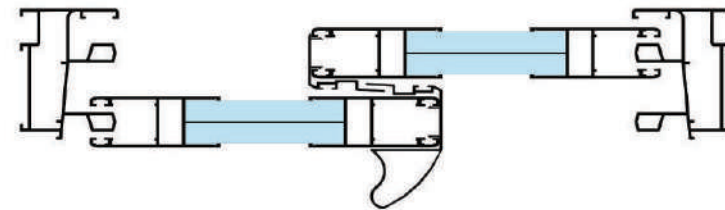



TOP VIEW

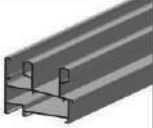
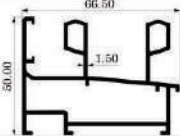

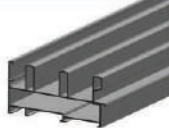
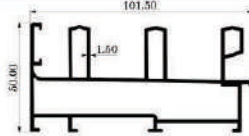

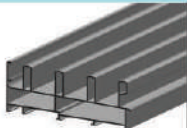
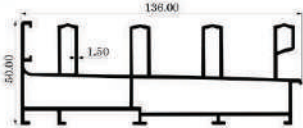
27MM TWO TRACK		
		Premium Model
		Section Number 1037 Weight (kg/mt) 1.168

27MM THREE TRACK		
		Premium Model
		Section Number 1174 Weight (kg/mt) 1.676

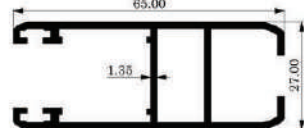
27MM FOUR TRACK		
		Single Leg Section
		Section Number 1133 Weight (kg/mt) 2.466

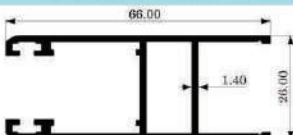
27MM SHUTTER		
		Single Glass Shutter
		Section Number 1079 Weight (kg/mt) 0.826

27MM SHUTTER		
		DGU Glass Shutter
		Section Number 1131 Weight (kg/mt) 0.778

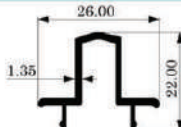
27MM SHUTTER CAP		
		Meeting Section
		Section Number 1129 Weight (kg/mt) 0.254

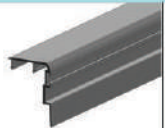
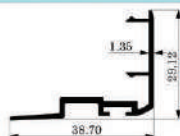
27MM INTERLOCK CLIP		
		Universal Clip
		Section Number 1001 Weight (kg/mt) 0.303

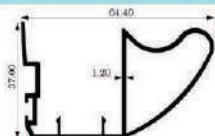
27MM INTERLOCK CLIP		
		Reinforcement Interlock
		Section Number 1197 Weight (kg/mt) 0.711

MOSQUITO CLIP		
		Mosquito Screen Fitting Clip
		Section Number 1269 Weight (kg/mt) N/A



V2965EDW

29 MM SLIDING SYSTEM

KEY FEATURES

- Premium Quality Aluminum Profiles
- European Design
- Glazing from 5mm to 20mm
- Single Roller Capacity 65 kg
- Double Roller Capacity 110-165kg
- Smooth & Effortless in movement
- Manual concealed & Multipoint locksystem
- Provision for insect screen
- Available in Anodized, Powder Coating, PVDF & Wood Finish
- Design for Mid to Large size shutter sliding
- Alloy 6063-T6 Temper as per IS- 6477 1983 for dimensional tolerances and Mechanical properties
- Bug & Bugler proof window
- Dust Resistance & Better Sound Reduction
- Available in Clear Glass, Reflective Glass, Toughned Glass, DGU Glass & Laminated Glass

VIJAY ALUMINIUM



THREE TRACK WITH FLY SCREEN SHUTTER

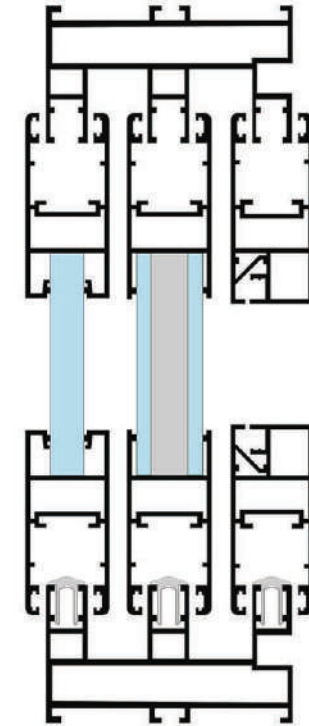
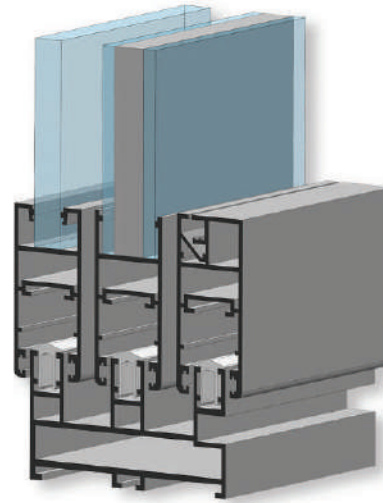

SIDE VIEW

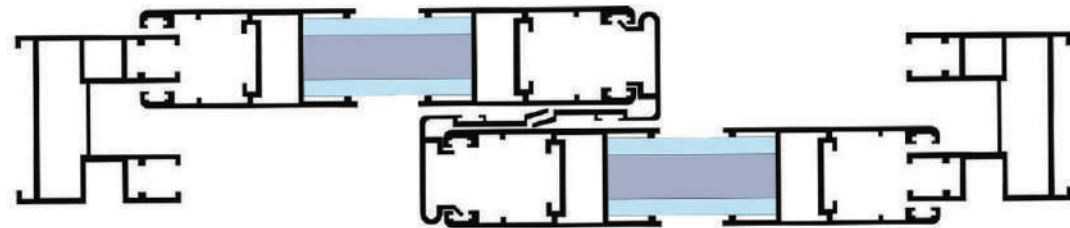

TOP VIEW



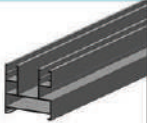
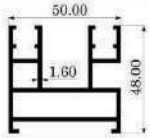

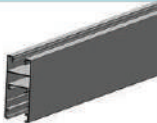
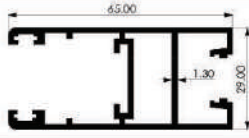
29MM TWO TRACK		
		Basic Type
		Section Number 1029
		Weight (kg/mt) 1.150

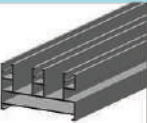
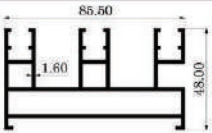
29MM SHUTTER		
		4-8 mm Glass Shutter
		Section Number 1028
		Weight (kg/mt) 0.942

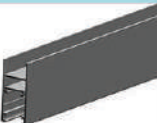
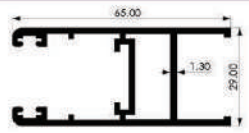
29MM THREE TRACK		
		Basic Type
		Section Number 1027
		Weight (kg/mt) 1.675

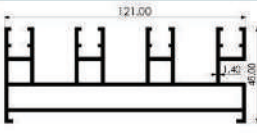
29MM SHUTTER		
		8-20 mm Glass Shuter
		Section Number 1096
		Weight (kg/mt) 0.849

29MM FOUR TRACK		
		Basic Type
		Section Number 1216
		Weight (kg/mt) 2.344

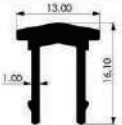
29MM TRACK RAIL CAP		
		"V" Type
		Section Number 1107
		Weight (kg/mt) 0.156

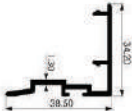
29 MM INTERLOCK CLIP		
		Universal Clip
		Section Number 1002
		Weight (kg/mt) 0.361



V3265EWD

32 MM SLIDING SYSTEM

KEY FEATURES

- Premium Quality Aluminum Profiles
- European Design
- Glazing from 5mm to 22mm
- Single Roller Capacity 70 kg
- Double Roller Capacity 110-165kg
- Smooth & Effortless in movement
- Manual concealed & Multipoint locksystem
- Provision for insect screen
- Available in Anodized, Powder Coating, PVDF & Wood Finish
- Design for Mid. And Large size shutter sliding
- Alloy 6063-T6 Temper as per IS- 6477 1983 for dimensional tolerances and Mechanical properties
- Bug & Bugler proof window
- Dust Resistance & Better Sound Reduction
- Available in Clear Glass, Reflective Glass, Toughned Glass, DGU Glass & Laminated Glass

VIJAY ALUMINIUM



TWO TRACK SHUTTER

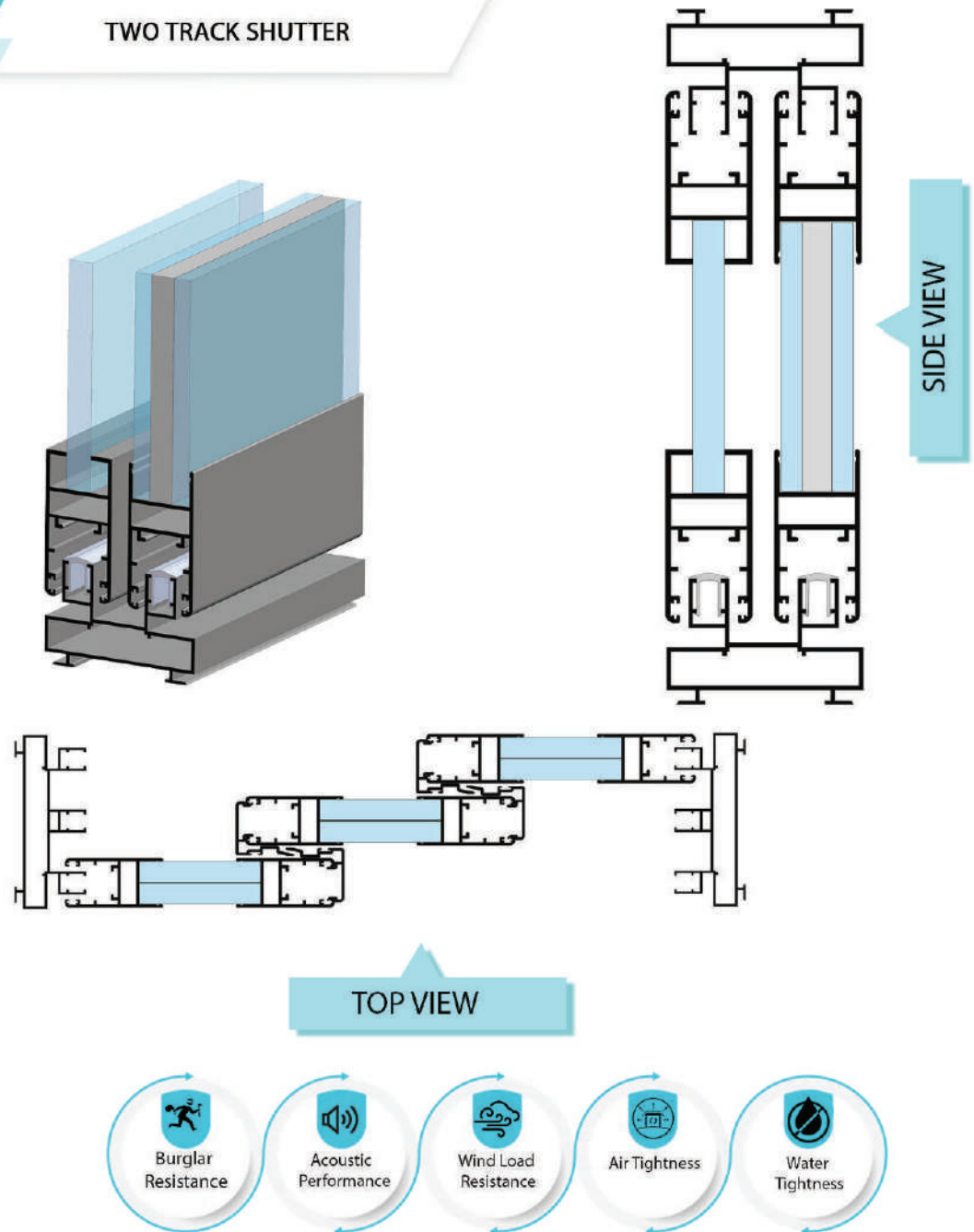

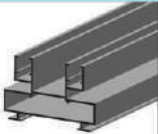
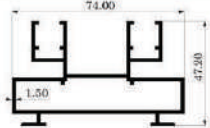
32MM TWO TRACK		
		Long Base Type
		Section Number 1088 Weight (kg/mt) 1.444

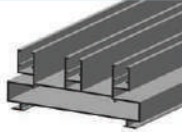
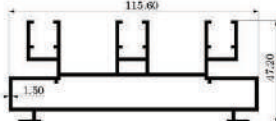
32MM THREE TRACK		
		Long Base Type
		Section Number 1016 Weight (kg/mt) 2.081

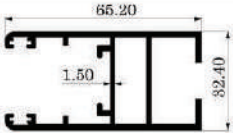
32MM SHUTTER		
		4- 8 mm Glass Shutter
		Section Number 1089 Weight (kg/mt) 1.038

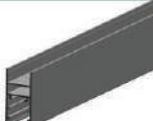
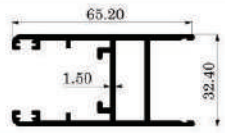
32MM SHUTTER		
		8- 22 mm Glass Shutter
		Section Number 1090 Weight (kg/mt) 0.947

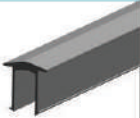
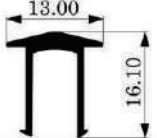
32MM TRACK RAIL CLIP		
		"V" Type
		Section Number 1192 Weight (kg/mt) 0.151

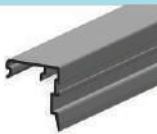
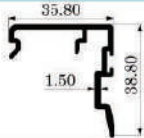
32MM INTERLOCK CLIP		
		Universal clip
		Section Number 1091 Weight (kg/mt) 0.561



V3265EWD

32 MM SLIDING SYSTEM

KEY FEATURES

- Premium Quality Aluminum Profiles
- European Design
- Glazing from 5mm to 22mm
- Single Roller Capacity 70 kg
- Double Roller Capacity 110-165kg
- Smooth & Effortless in movement
- Manual concealed & Multipoint locksystem
- Provision for insect screen
- Available in Anodized, Powder Coating, PVDF & Wood Finish
- Design for Mid to Large size shutter sliding
- Alloy 6063-T6 Temper as per IS- 6477 1983 for dimensional tolerances and Mechanical properties
- Bug & Bugler proof window
- Dust Resistance & Better Sound Reduction
- Available in Clear Glass, Reflective Glass, Toughned Glass, DGU Glass & Laminated Glass

VIJAY ALUMINIUM



TWO TRACK WITH
MOSQUITO SHUTTER OPT.

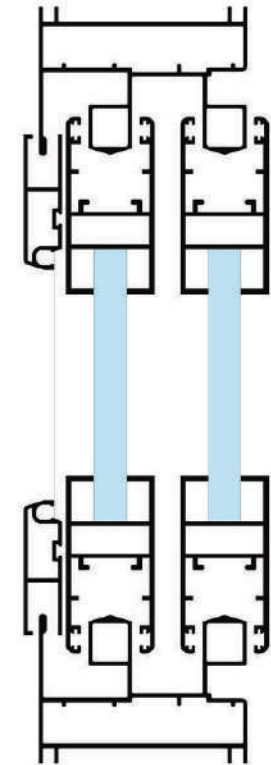
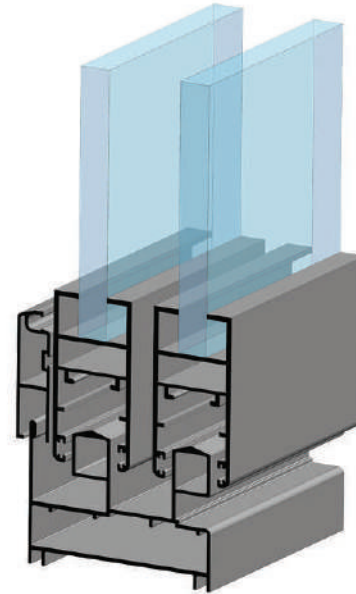

SIDE VIEW

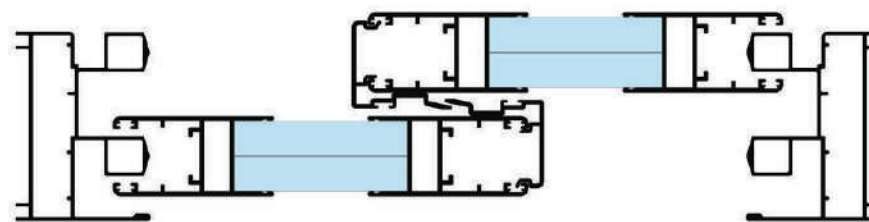



TOP VIEW

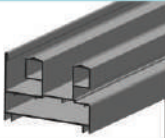
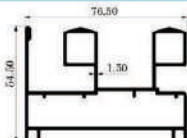

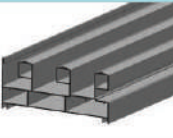
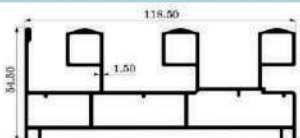
32MM TWO TRACK		
		Premium Model
		Section Number 1117 Weight (kg/mt) 1.535

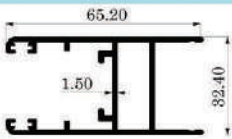

32MM THREE TRACK		
		Premium Model
		Section Number 1122 Weight (kg/mt) 2.254

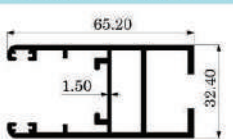
32MM SHUTTER		
		8- 22 mm Glass Shutter
		Section Number 1090 Weight (kg/mt) 0.947

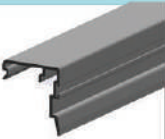
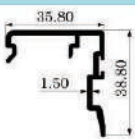
32MM SHUTTER		
		4- 8 mm Glass Shutter
		Section Number 1089 Weight (kg/mt) 1.038

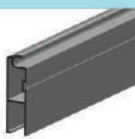
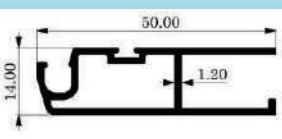
32MM INTERLOCK CLIP		
		Universal Clip
		Section Number 1091 Weight (kg/mt) 0.561

32MM SHUTTER		
		Mosquito Shutter
		Section Number 1005 Weight (kg/mt) 0.432

32MM MOSQUITO CLIP		
		Mosquito Screen Fitting Clip
		Section Number 1269 Weight (kg/mt) N/A



V3575EWD

35 MM SLIDING SYSTEM

KEY FEATURES

- Premium Quality Aluminum Profiles
- European Design
- Glazing from 5mm to 24mm
- Single Roller Capacity 70 kg
- Double Roller Capacity 110-165kg
- Smooth & Effortless in movement
- Manual concealed & Multipoint locksystem
- Provision for insect screen
- Available in Anodized, Powder Coating, PVDF & Wood Finish
- Reinforced Profiles available in larger opening
- Design for Mid to Large size shutter sliding
- Alloy 6063-T6 Temper as per IS- 6477 1983 for dimensional tolerances and Mechanical properties
- Bug & Bugler proof window
- Dust Resistance & Better Sound Reduction
- Available in Clear Glass, Reflective Glass, Toughned Glass, DGU Glass & Laminated Glass

VIJAY ALUMINIUM



TWO TRACK WITH SLIM INTERLOCK SECTION

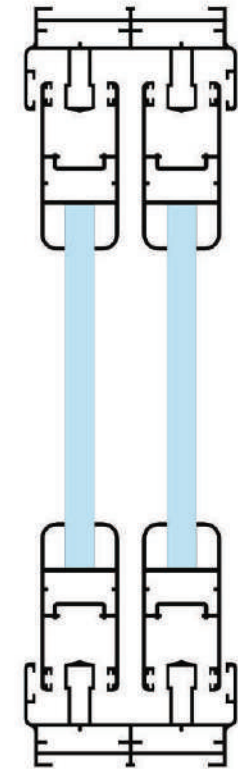
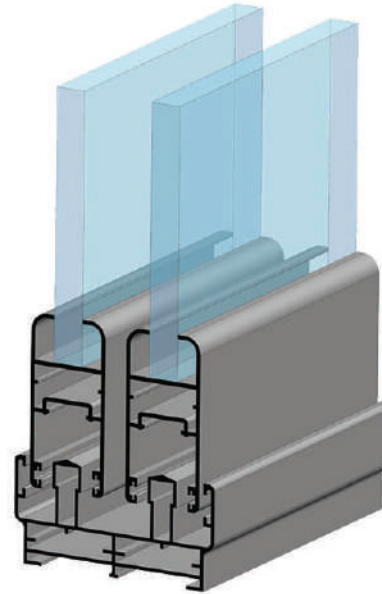

SIDE VIEW

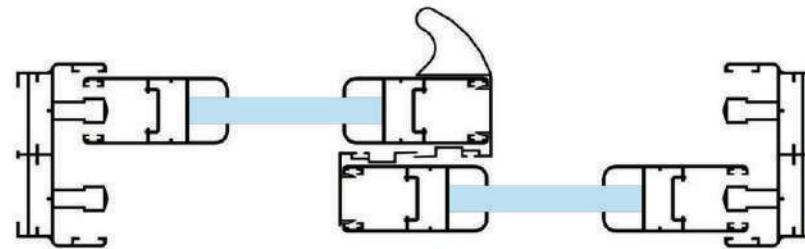



TOP VIEW

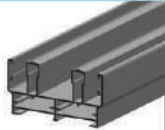
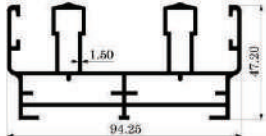

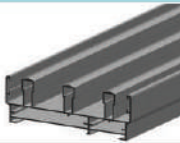
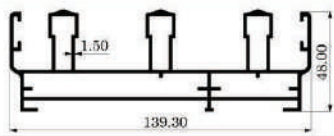
35MM TWO TRACK		
		Basic Type
		Section Number 1128 Weight (kg/mt) 1.972

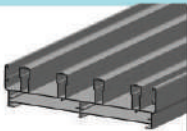
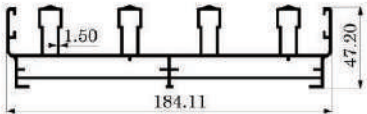
35MM THREE TRACK		
		Basic Type
		Section Number 1130 Weight (kg/mt) 2.480

35MM FOUR TRACK		
		Both Side leg Section
		Section Number 1135 Weight (kg/mt) 3.109

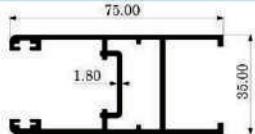
35MM SHUTTER		
		10- 24 mm Glass Shutter
		Section Number 1144 Weight (kg/mt) 1.319

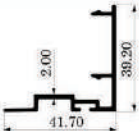
35MM INTERLOCK CLIP		
		Universal Clip
		Section Number 1116 Weight (kg/mt) 0.468

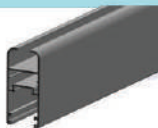
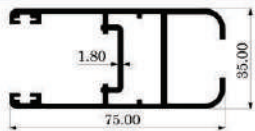
35MM SHUTTER		
		5 - 10 mm Glass Shutter
		Section Number 1127 Weight (kg/mt) 1.385

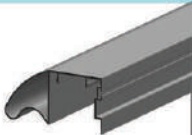
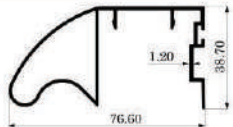
35MM INTERLOCK CLIP		
		Reinforcement Interlock
		Section Number 1119 Weight (kg/mt) 0.781



V3783EWD

37 MM SLIDING SYSTEM

KEY FEATURES

- Premium Quality Aluminum Profiles
- European Design
- Glazing from 5mm to 27mm
- Single Roller Capacity 80 kg
- Double Roller Capacity 110-165kg
- Smooth & Effortless in movement
- Manual concealed & Multipoint locksystem
- Provision for insect screen
- Available in Anodized, Powder Coating, PVDF & Wood Finish
- Design for Mid to Large size shutter sliding
- Alloy 6063-T6 Temper as per IS- 6477 1983 for dimensional tolerances and Mechanical properties
- Bug & Bugler proof window
- Dust Resistance & Better Sound Reduction
- Available in Clear Glass, Reflective Glass, Toughned Glass, DGU Glass & Laminated Glass

VIJAY ALUMINIUM



TWO TRACK SYSTEM

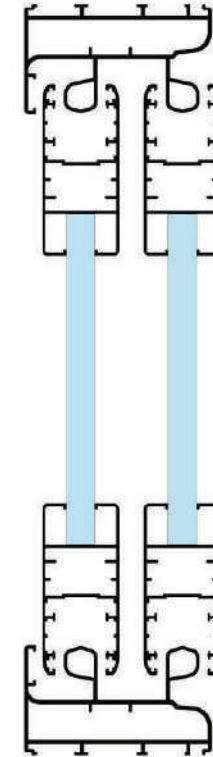
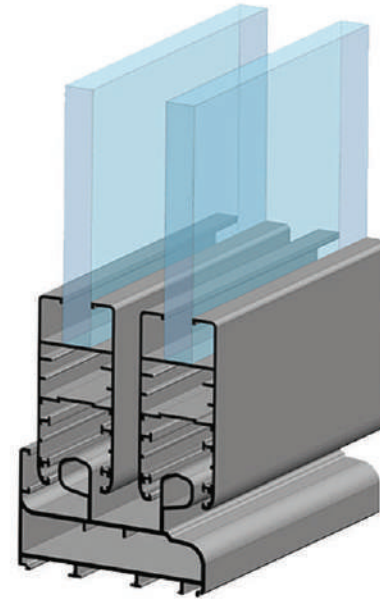

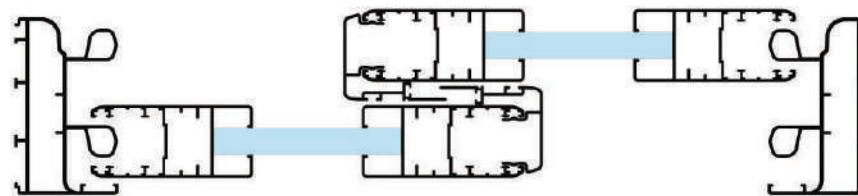

SIDE VIEW



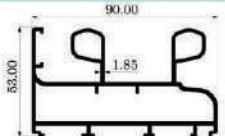

TOP VIEW

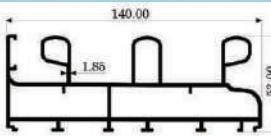

37MM TWO TRACK		
		Premium Type
		Section Number 1075 Weight (kg/mt) 1.672

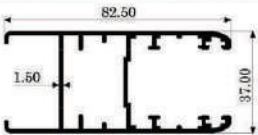
37MM THREE TRACK		
		Premium Type
		Section Number 1130 Weight (kg/mt) 2.480

37MM SHUTTER		
		18-27 mm Glass Shutter
		Section Number 1210 Weight (kg/mt) 1.328

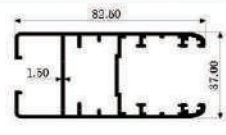
37MM SHUTTER		
		4- 12 mm Glass Shutter
		Section Number 1078 Weight (kg/mt) 1.397

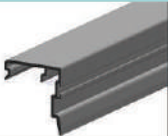
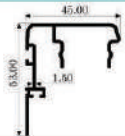
37MM INTERLOCK CLIP		
		Shutter Interlock Clip
		Section Number 1209 Weight (kg/mt) 0.685

CASMENT WINDOW SYSTEM

Second most efficient window. Casement windows are the second most energy-efficient, after fixed-pane windows. The window sash presses against the frame on closing, creating an airtight seal. This helps prevent air entry and leakage.

FEATURES & BENEFITS

- Coextruded glazing bead makes water seepages nearly impossible
- Glass range from 5mm to 12mm and 19mm to 22mm
- Air-tight seals for Better noise, dust, heat and pollution reductions.
- Available in variety of colours and designs.

RECOMMENDED FOR

- Bedrooms, Balconies, Large/Tall openings







V4054EWD

40 MM CASEMENT SYSTEM

KEY FEATURES

- Premium Quality Aluminum Profiles
- European Design
- Glazing from 4mm to 20mm
- Square shapes clip
- Glazing from inside for security
- Co- extruded gasket which can withstand -30'c to + 50'c
- Corner joints & T-Joints for stronger mechanical joinery
- Single Point locking system
- Smooth & effortless in operation
- Design for medium opening and mid. wind load condition
- Internal & External opening system
- Alloy 6063-T6 Temper as per IS-6477 1983 for dimensional tolerances and mechanical properties
- Dust Resistance & better sound Reduction
- Bugler proof Window system
- Available in clear Glass, Reflective Glass, Toughned Glass, Laminated Glass

VIJAY ALUMINIUM



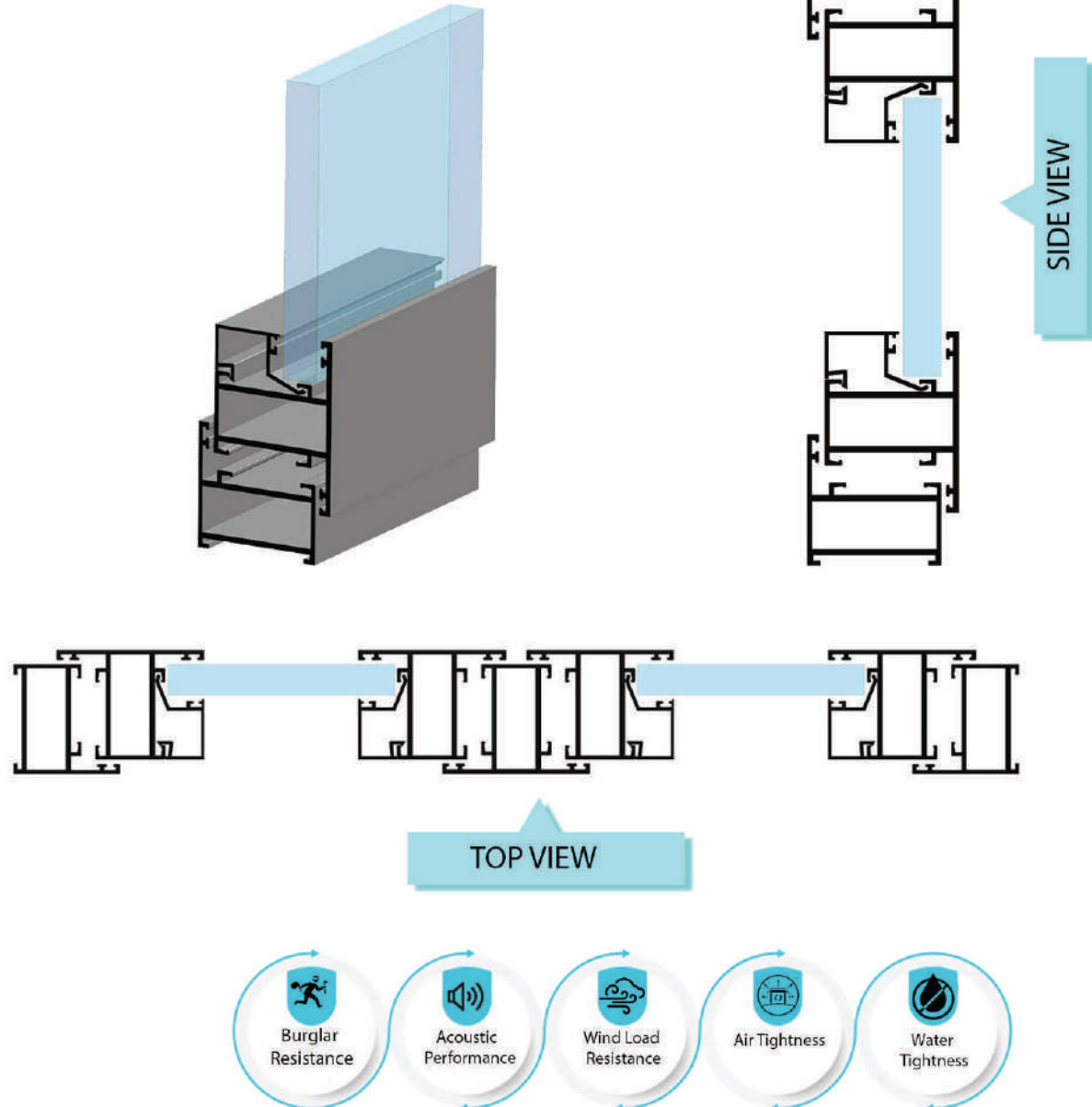

CASEMENT WINDOW SYSTEM

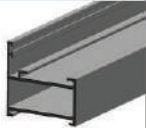
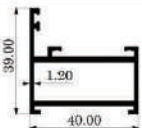

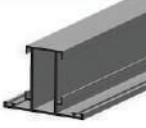
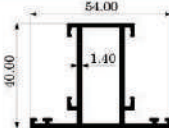

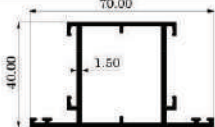
40MM ECO FRAME OUTER		
		Eco Frame Outer
		Section Number 1231
		Weight (kg/mt) 0.548

40MM ECO MULLION		
		Eco Mullion Section
		Section Number 1246
		Weight (kg/mt) 0.656

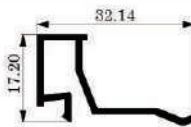
40MM ECO BIG MULLION		
		Box Mullion Section
		Section Number 1232
		Weight (kg/mt) 0.787

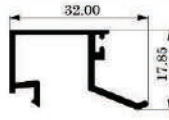
40MM GLASS CLIP		
		Glass Clip
		Section Number 1248
		Weight (kg/mt) 0.181

40MM GLASS CLIP		
		Glass Clip
		Section Number 1230
		Weight (kg/mt) 0.211

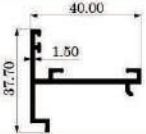
40MM CLIP		
		Reverse Adapter
		Section Number 1061
		Weight (kg/mt) 0.438



V4246EWD

42 MM CASEMENT SYSTEM

KEY FEATURES

- Premium Quality Aluminum Profiles
- European Design
- Glazing from 4mm to 20mm
- Square shapes clip
- Glazing from inside for security
- Co- extruded gasket which can withstand -30'c to + 50'c
- Corner joints & T-Joints for stronger mechanical joinery
- Single Point locking system
- Smooth & effortless in operation
- Design for medium opening and mid. wind load condition
- Internal & External opening system
- Alloy 6063-T6 Temper as per IS-6477 1983 for dimensional tolerances and mechanical properties
- Dust Resistance & better sound Reduction
- Bugler proof Window system
- Available in clear Glass, Reflective Glass, Toughned Glass, Laminated Glass, DGU Glass

VIJAY ALUMINIUM



CASEMENT WINDOW SYSTEM

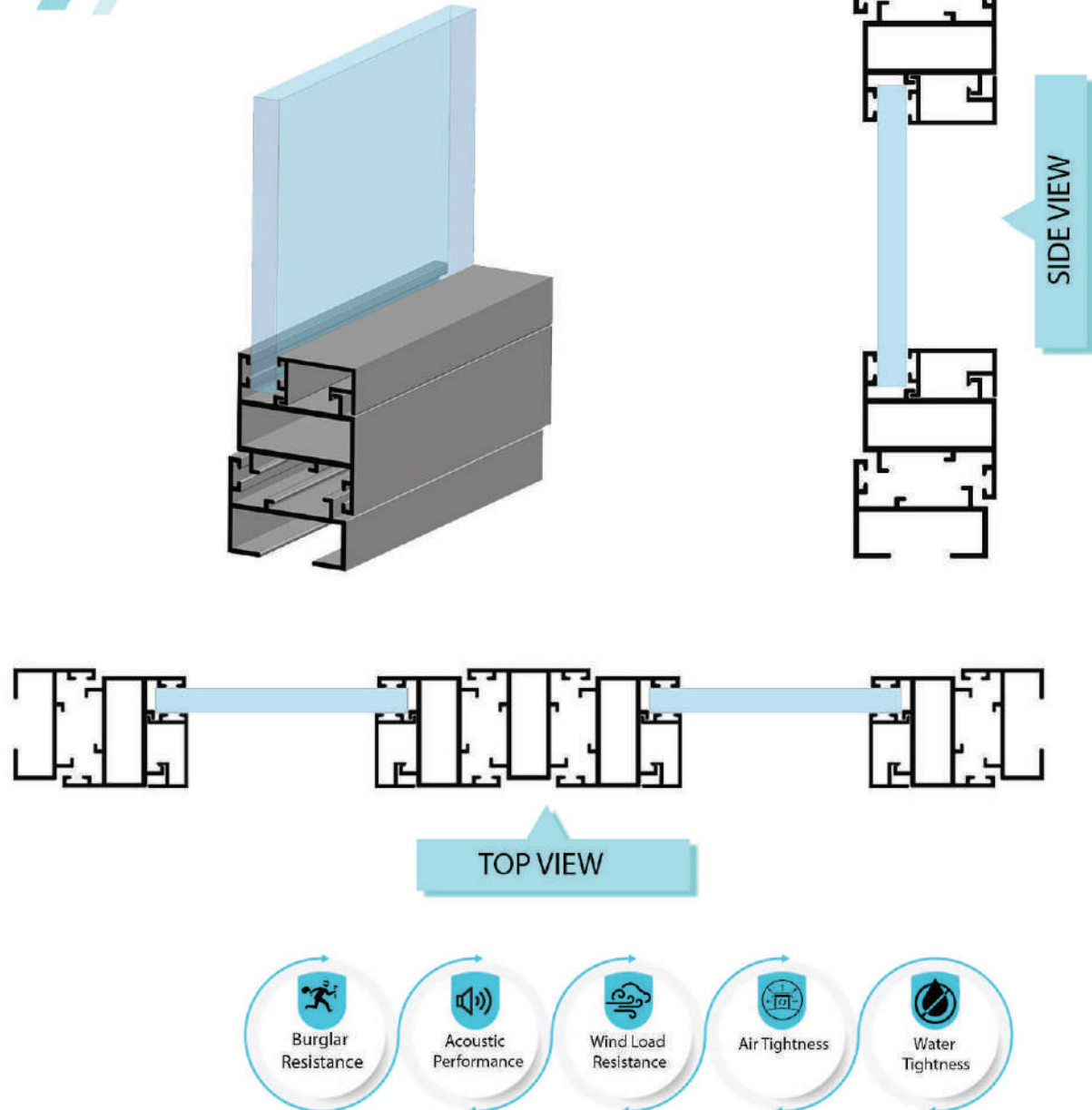

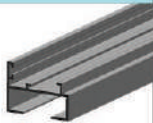
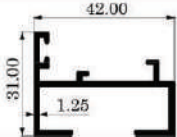
42MM FRAME		
		Frame Section
		Section Number 1231
		Weight (kg/mt) 0.436

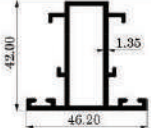
42MM MULLION		
		Mullion Section
		Section Number 1246
		Weight (kg/mt) 0.656

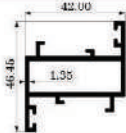
42MM SHUTTER		
		Shutter Section
		Section Number 1232
		Weight (kg/mt) 0.656

42MM GLASS CLIP		
		Glass Clip
		Section Number 1248
		Weight (kg/mt) 0.226



V5078EWD

50 MM CASEMENT SYSTEM

KEY FEATURES

- Premium Quality Aluminum Profiles
- European Design
- Glazing from 4mm to 30mm
- Molding & Square shapes clip
- Glazing from inside for security
- Co- extruded gasket which can withstand -30'c to + 50'c
- Corner joints & T-Joints for stronger mechanical joinery
- Single Point & Multi Point locking system
- Smooth & effortless in operation
- Design for medium opening and mid. wind load condition
- Internal & External opening system
- Alloy 6063-T6 Temper as per IS-6477 1983 for dimensional tolerances and mechanical properties
- Dust Resistance & better sound Reduction
- Bugler proof Window system
- Available in clear Glass, Reflective Glass, Toughned Glass, Laminated Glass

VIJAY ALUMINIUM



CASEMENT WINDOW SYSTEM

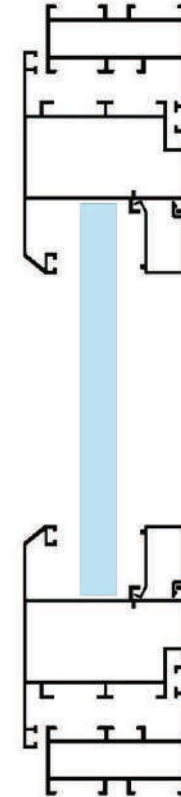
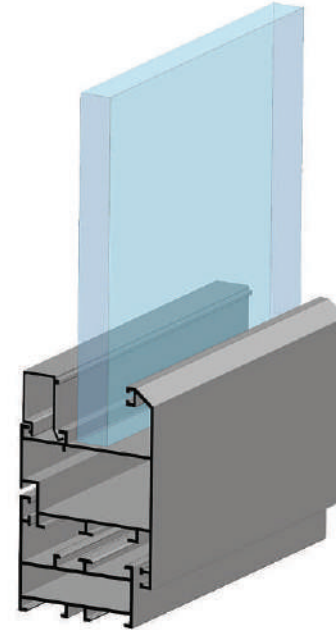

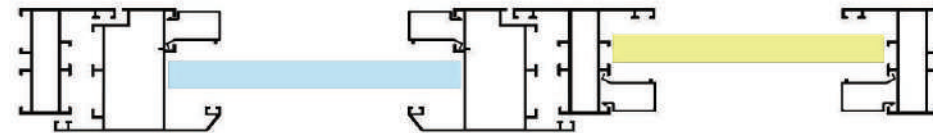

SIDE VIEW



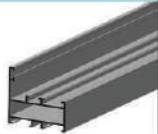
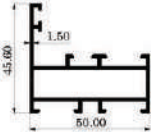

TOP VIEW



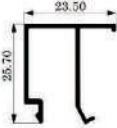

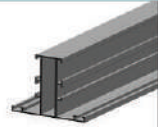
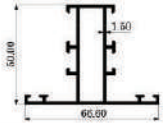
50MM FRAME		
		Outer Frame
		Section Number 1105
		Weight (kg/mt) 0.868

GLASS CLIP - 1		
		Glass Clip
		Section Number 1097
		Weight (kg/mt) 0.303

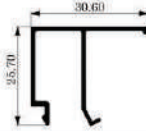
50MM MULLION		
		Mullion Section
		Section Number 1103
		Weight (kg/mt) 1.089

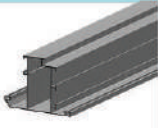
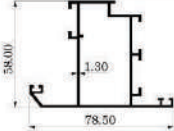
GLASS CLIP - 2		
		Glass Clip
		Section Number 1098
		Weight (kg/mt) 0.241

50MM SHUTTER		
		Outside Opening Shutter
		Section Number 1007
		Weight (kg/mt) 1.055

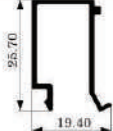
GLASS CLIP - 3		
		Glass Clip
		Section Number 1100
		Weight (kg/mt) 0.219



V5266EWD

52 MM CASEMENT SYSTEM

KEY FEATURES

- Premium Quality Aluminum Profiles
- European Design
- Glazing from 4mm to 30mm
- Molding & Square shapes clip
- Glazing from inside for security
- Co- extruded gasket which can withstand -30'c to + 50'c
- Corner joints & T-Joints for stronger mechanical joinery
- Single Point locking system
- Smooth & effortless in operation
- Design for medium opening and mid. wind load condition
- Internal & External opening system
- Alloy 6063-T6 Temper as per IS-6477 1983 for dimensional tolerances and mechanical properties
- Dust Resistance & better sound Reduction
- Bugler proof Window system
- Available in clear Glass, Reflective Glass, Toughned Glass, Laminated Glass

VIJAY ALUMINIUM



CASEMENT WINDOW SYSTEM

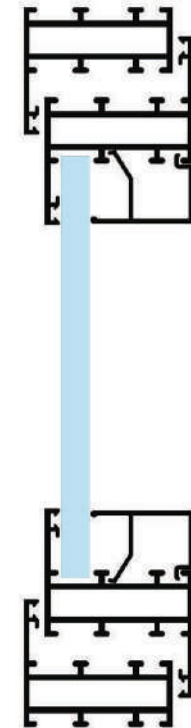
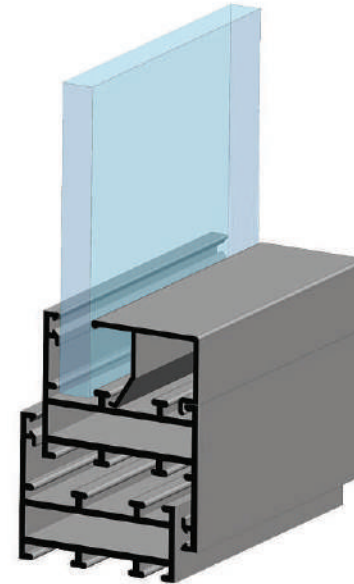



SIDE VIEW



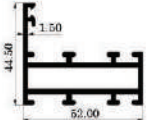

TOP VIEW



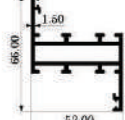

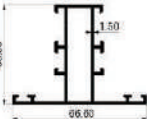
52MM FRAME		
		Outer Frame
		Section Number 1105
		Weight (kg/mt) 0.868

52MM SHUTTER		
		Shutter Section
		Section Number 1007
		Weight (kg/mt) 1.055

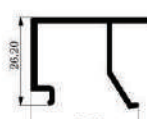
52MM MULLION		
		Mullion Section
		Section Number 1103
		Weight (kg/mt) 1.089

GLASS CLIP - 1		
		Glass Clip
		Section Number 1097
		Weight (kg/mt) 0.303

GLASS CLIP - 2		
		Glass Clip
		Section Number 1098
		Weight (kg/mt) 0.241

DOOR SYSTEM

A much sought-after choice for covering large spans that link inside with outside. These stunning looking doors glide back and forth on feather touch rollers, with very little effort, and provide rich panoramic views through its expansive glass panes that come without any dividers. Incredibly smooth to operate, Openable allows for seamless integration of living or working environment into the surrounding nature, with almost no barriers, giving you a sense of amazingly wide spaces.

FEATURES & BENEFITS

- This is for big size opening and comes with locking system.
- Coextruded glazing bead makes water seepages nearly impossible
- Glass thickness from 5mm-12mm & 19mm to 22mm
- Possible with and without mosquito mesh
- Possible with single and double glaze
- System can withstand against heavy wind resistance
- Separate drainage chamber and slope on the frame, assist to drain out water more quickly

RECOMMENDED FOR

- Balconies, Villas, Luxury Bungalows and Large Openings







V4070EDS

40 MM DOOR SYSTEM

KEY FEATURES

- Premium Quality Aluminum Profiles
- European Design
- Glazing from 4mm to 20mm
- Square shapes clip
- Glazing from inside for security
- Co- extruded gasket which can withstand -30'c to + 50'c
- Corner joints & T-Joints for stronger mechanical joinery
- Single Point locking system
- Smooth & effortless in operation
- Design for medium opening and mid. wind load condition
- Internal & External opening system
- Alloy 6063-T6 Temper as per IS-6477 1983 for dimensional tolerances and mechanical properties
- Dust Resistance & better sound Reduction
- Bugler proof Door system
- Available in Clear Glass, Reflective Glass, Toughned Glass & Laminated Glass

VIJAY ALUMINIUM



DOOR SYSTEM

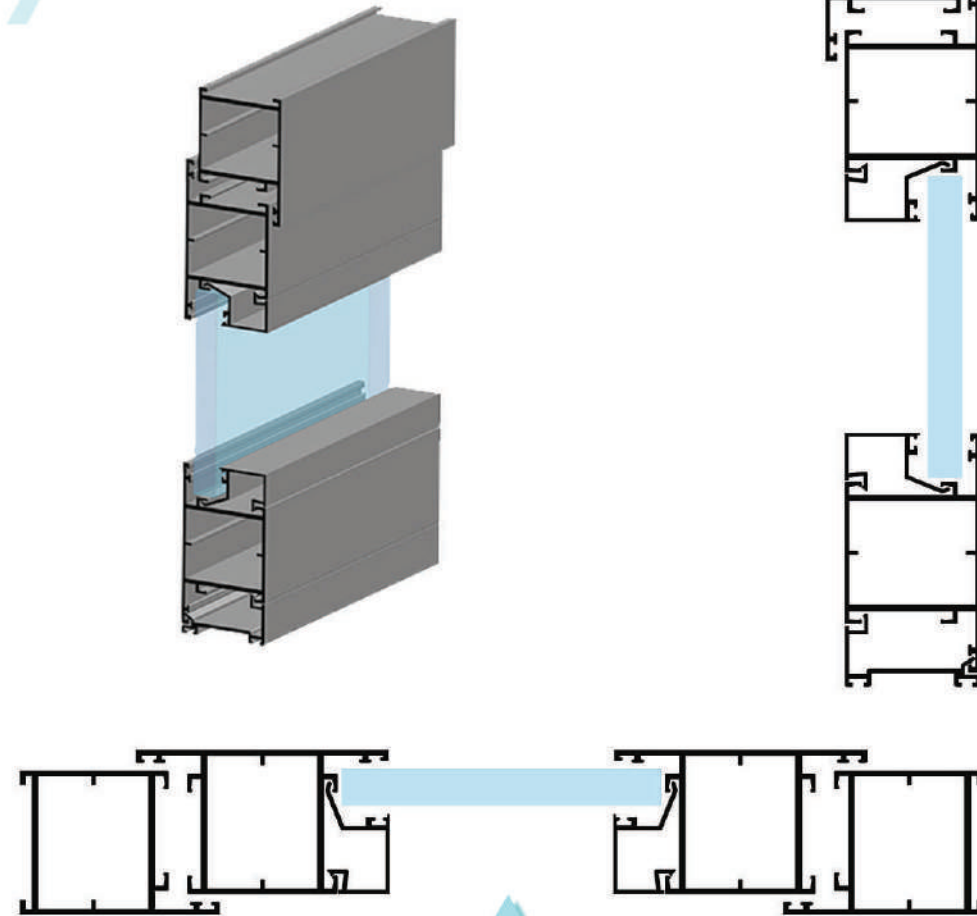

SIDE VIEW

TOP VIEW



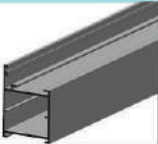
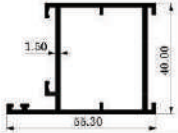

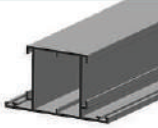

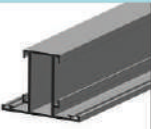
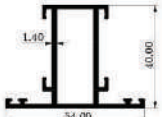
40MM OUTER BIG FRAME		
		Big Frame
		Section Number 1110 Weight (kg/mt) 0.792

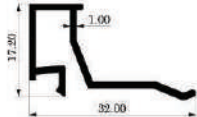
40MM BIG MULLION		
		Big Mullion
		Section Number 1137 Weight (kg/mt) 0.787

40MM ECO MULLIAN		
		Eco Mullion Section
		Section Number 1133 Weight (kg/mt) 0.656

GLASS CLIP		
		Glass clip
		Section Number 1079 Weight (kg/mt) 0.181

40MM BOTTOM CLIP		
		Shutter Bottom Clip
		Section Number 1131 Weight (kg/mt) 0.308

GLASS CLIP		
		Glass clip
		Section Number 1129 Weight (kg/mt) 0.211

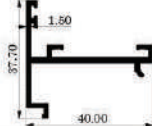
40MM REVERSE ADAPTOR		
		Reverse Adaptor
		Section Number 1001 Weight (kg/mt) 0.438



V5096EDS

50 MM DOOR SYSTEM

KEY FEATURES

- Premium Quality Aluminum Profiles
- European Design
- Glazing from 4mm to 34mm
- Square shapes clip
- Glazing from inside for security
- Co- extruded gasket which can withstand -30'c to + 50'c
- Corner joints & T-Joints for stronger mechanical joinery
- Single Point & Multi Point locking system
- Smooth & effortless in operation
- Design for medium opening and mid. & Large wind load condition
- Internal & External opening system
- Alloy 6063-T6 Temper as per IS-6477 1983 for dimensional tolerances and mechanical properties
- Dust Resistance & better sound Reduction
- Bugler proof Door system
- Available in Clear Glass, Reflective Glass, Toughned Glass, DGU Glass & Laminated Glass

VIJAY ALUMINIUM



DOOR SYSTEM

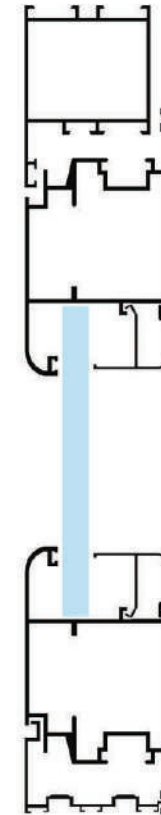
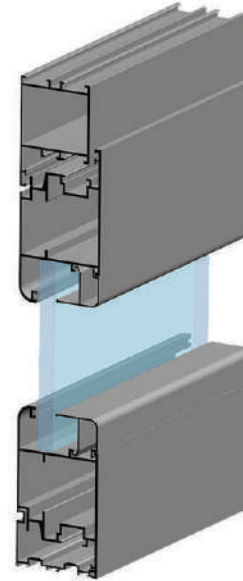

SIDE VIEW



TOP VIEW

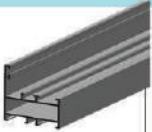
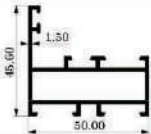

50MM FRAME		
		Outer Frame
		Section Number 1110 Weight (kg/mt) 0.868

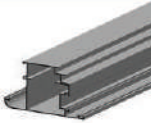
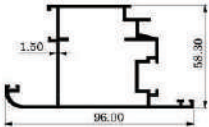
50MM DOOR SHUTTER		
		Door Shutter
		Section Number 1137 Weight (kg/mt) 1.423

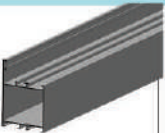
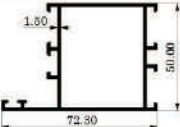
50MM BIG FRAME		
		Big Outer Frame
		Section Number 1133 Weight (kg/mt) 1.076

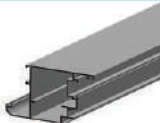
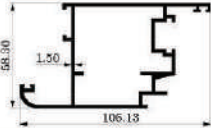
50MM DOOR SHUTTER		
		Door Shutter
		Section Number 1079 Weight (kg/mt) 1.599

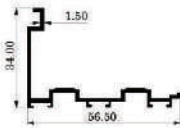
50MM CLIP SECTION		
		Shutter Bottom Clip
		Section Number 1131 Weight (kg/mt) 0.532

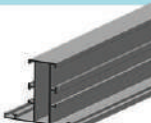
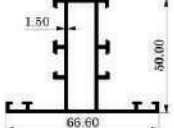
50MM MULLION		
		Mullion Section
		Section Number 1129 Weight (kg/mt) 1.089

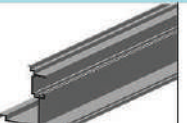
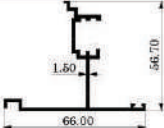
50MM CLIP SECTION		
		EURO Mullion
		Section Number 1001 Weight (kg/mt) 0.732

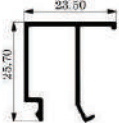
GLASS CLIP - 1		
		Glass Clip
		Section Number 1097 Weight (kg/mt) 0.303

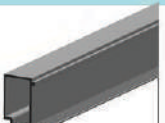
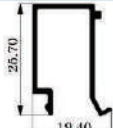
GLASS CLIP - 3		
		Glass Clip
		Section Number 1100 Weight (kg/mt) 0.219

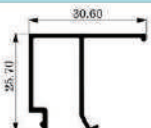
GLASS CLIP - 2		
		Glass Clip
		Section Number 1098 Weight (kg/mt) 0.241

DOOR



SLIDING SYSTEM



CASEMENT WINDOW



SLIDING SYSTEM ACCESSORIES

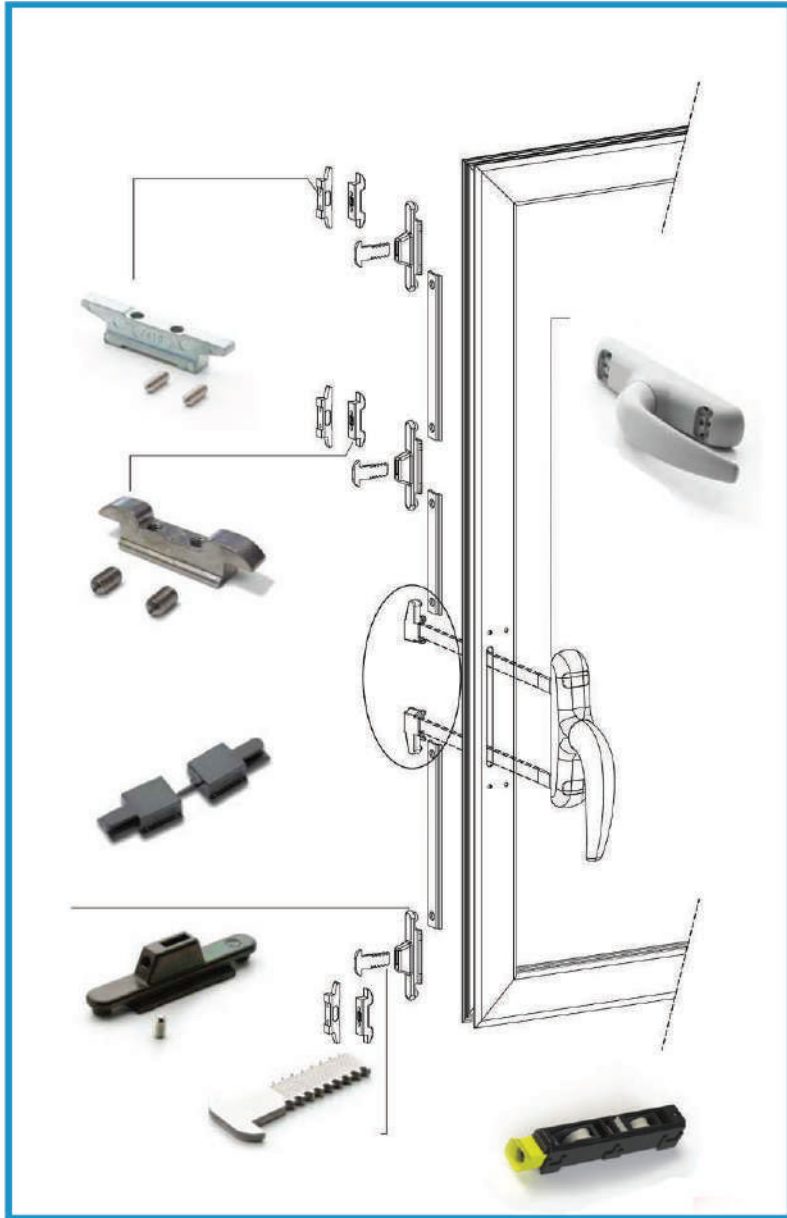

CASMENT SYSTEM ACCESSORIES

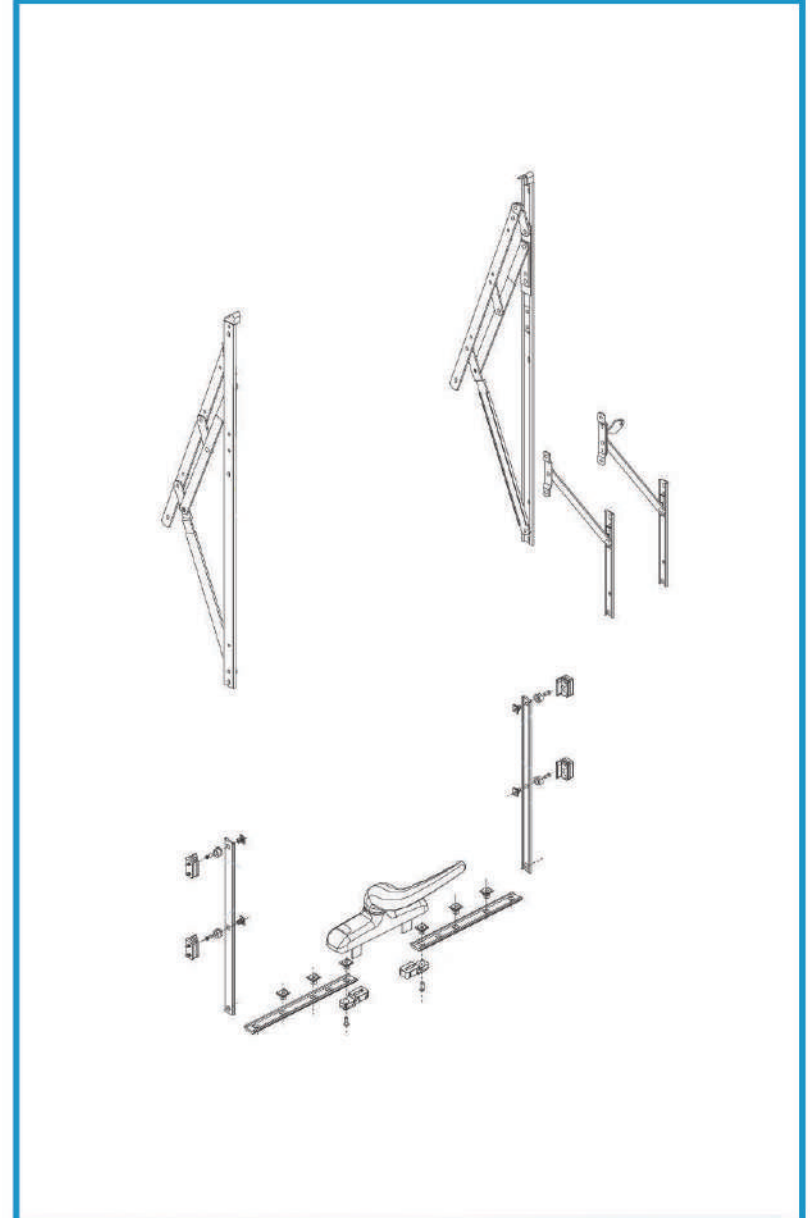

VIJAY ALUMINIUM



VIJAY
ALUMINIUM



vijay_aluminium@yahoo.in



**Opp. Mohan Cinema Nr. Navnirman
Co. Op. Bank, Asarwa, Ahemedabad.
(380016)**

BHARAT PATEL
9426171769

BINOY PATEL
8758072718